

# Secciones

Línea con grupo incorporado

## DUKE P82 VC

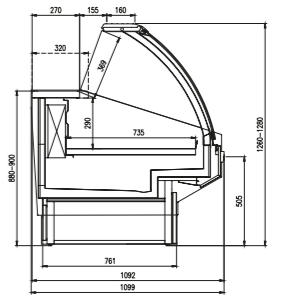
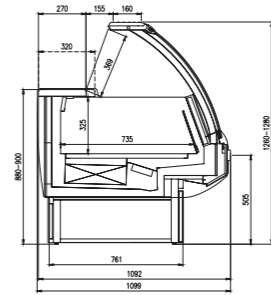
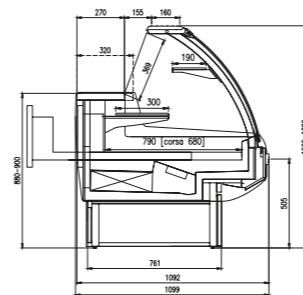
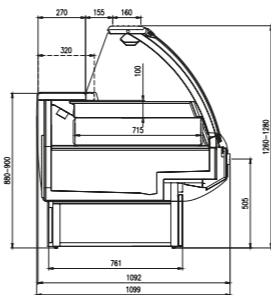
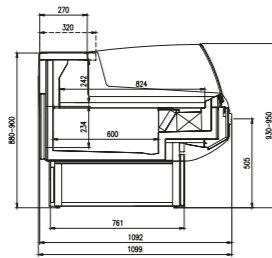
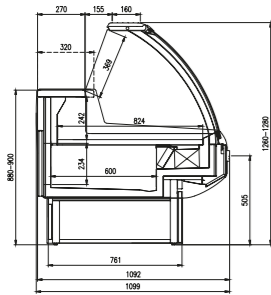

CARNE/GASTRONOMÍA

CARNE/GASTRONOMÍA/AS

PC

PASTELERÍA

BT

PESCADO

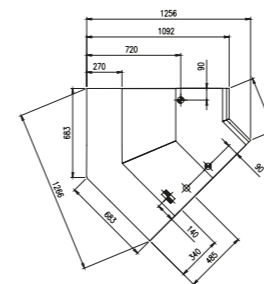
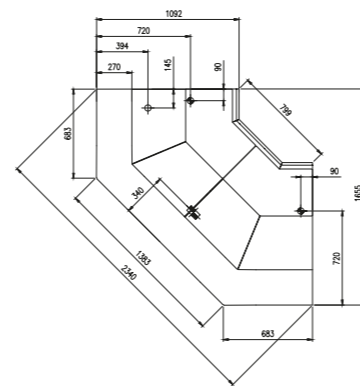
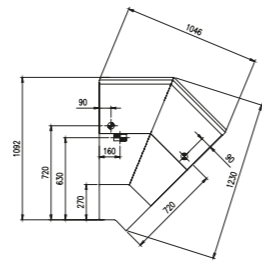
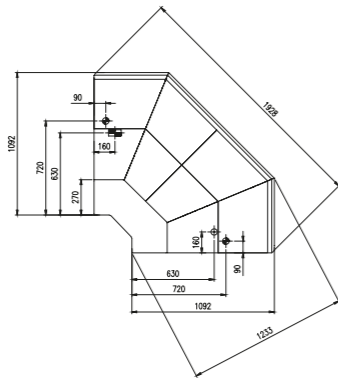
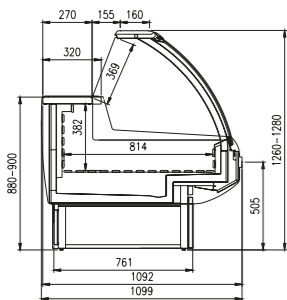

PAN

90 E

45 E

90 I

45 I

# Secciones

Línea con grupo incorporado

## DUKE P82 VDR

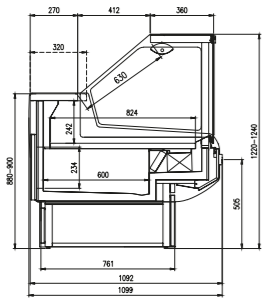

CARNE/GASTRONOMÍA

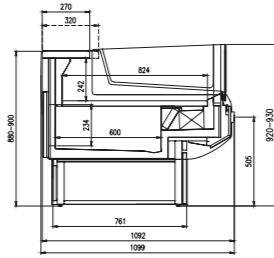

CARNE/GASTRONOMÍA/AS

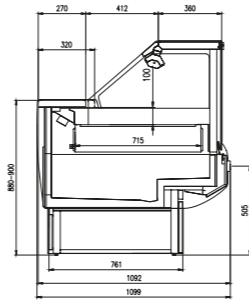

PC

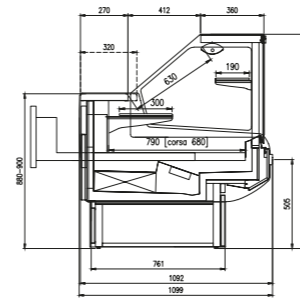

PASTELERÍA

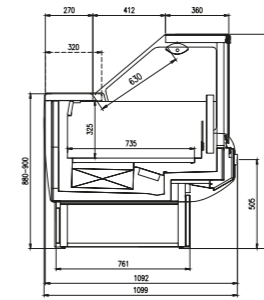

BT

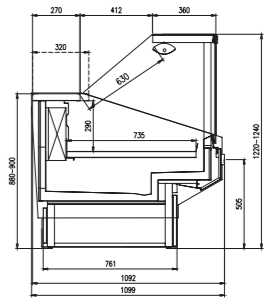

PESCADO

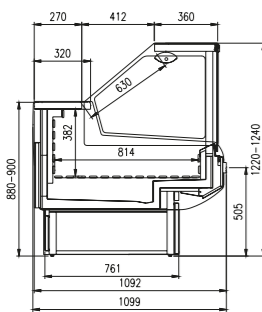

PAN

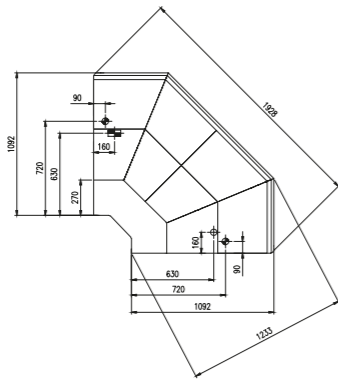

90 E

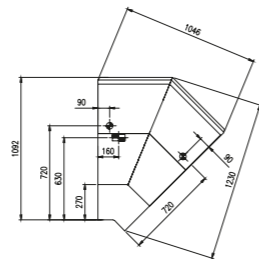

45 E

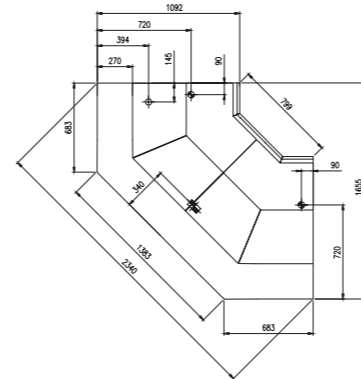

90 I

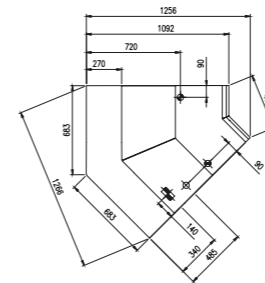

45 I